



ADVENT

ARCHITECTURAL
LIGHTING

REO

Interior Wall Sconce

ADA Compliant

Three Mounting Options

Multiple Finishes

Various Lens Options



BAL FINISH - TP05 PANEL

Reo Interior Sconce

The Reo series from Advent incorporates multiple faceplate options and finishes including wood laminates and embossed stainless steel patterns. Reo is further enhanced with the offering of the popular 3form® Varia translucent resin panels and Advent's hand-painted lenses. Reo is available in surface, semi-recessed and recessed mounts providing a sense of visual depth in a creative, low-profile and ADA compliant package.



Reo Interior Sconce

Reo – Surface Mount



The surface mount allows the fixture to be mounted to any wall surface while still complying with ADA requirements. This style enhances any space with a comforting glow rendered by the side illumination. When specified in our 3D open window style, this mount provides a sense of depth, without needing to recess the fixture.

Reo – Semi-Recessed Mount



The semi-recessed mount allows the fixture to be partially recessed into the wall cavity while still accenting the space with side illumination. This mounting style provides a sense of depth in a low-profile, ADA compliant package.

Reo – Recessed Mount



The recessed mount allows the housing to be fully recessed into the wall revealing only the faceplate. When specified in a 3D open window style, the recessed mount provides a sense of depth in a very low profile fixture. With a 1" wall projection, the recessed mount easily satisfies all ADA standards.

Contents

Product Features	2
Surface Mount Flush	4
Surface Mount 3D Window	6
Semi-Recessed Flush	8
Semi-Recessed 3D Window	10
Recessed Flush	12
Recessed 3D Window	14
Specifying Reo's Finishes	16
Finishes	17
Index	17

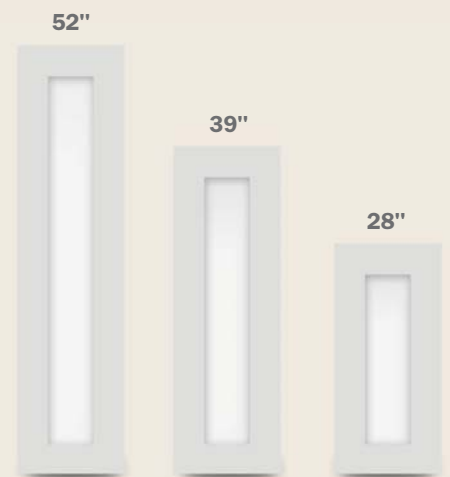

Reo Interior Sconce

Product Features

ADVENT



Vertical Mount
(BAL FINISH - TP01 PANEL)



Horizontal Mount
(BAL FINISH - TP04 PANEL)

Reo Design Details

Two window styles



3D Open Window



Flush Front Lens

Three ADA compliant mounting options



Surface



Semi-Recessed



Recessed

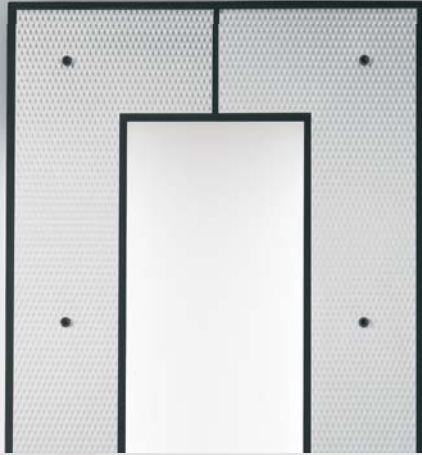

Add vibrant color



Red Color Gel Orange Color Gel Green Color Gel Blue Color Gel

Standard finishes



Brushed Solid Aluminum Choose from over 30 standard finishes. (See page 17)

Add color and texture



Bear Grass Gingko Thatch Quo Mezzo

Optional accents



Cherry Laminata Maple Laminata



Silver Beige Amber

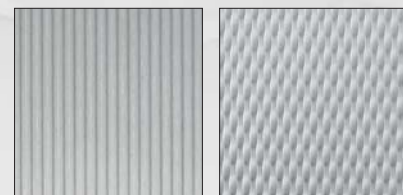

Embossed Stainless Steel-Linear Pattern Embossed Stainless Steel-Crosshatch Pattern

Reo Interior Sconce

Surface Mount - Flush Front Lens

ADVENT



AIW1526
(BAL FINISH - CG04 LENS)



AIW1526
(BAL FINISH - CG03 LENS)



Optional Color Lenses

Splash vibrant color throughout a space with Reo's color gels. The standard frosted white lens can be transformed to complement a design with these striking colored accents. Other gel colors are available upon request. Please consult factory for more details.

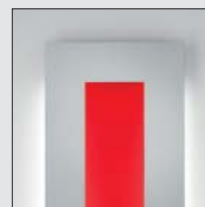

CG01 Red Color Gel



CG02 Orange Color Gel



CG03 Green Color Gel



CG04 Blue Color Gel

Sample model number: **AIW1520 - 2F14 - 120 - BAL - CG01 - ES1**

SELECT MODEL NO.	SELECT LAMPING	SELECT VOLTAGE	SELECT FINISH	SELECT LENS	SELECT OPTIONAL ACCENT																														
28" AIW1520	<p>Lamping Detail</p> <table border="1"> <tr><td>2F14</td><td>(2) F14WT5/Mini Bipin</td></tr> <tr><td>2F14DM</td><td>(2) F14WT5/Mini Bipin DM</td></tr> <tr><td>2F24</td><td>(2) F24WT5H0/Mini Bipin</td></tr> <tr><td>2F24DM</td><td>(2) F24WT5H0/Mini Bipin DM</td></tr> <tr><td>2F17</td><td>(2) F17WT8/Med Bipin</td></tr> </table>	2F14	(2) F14WT5/Mini Bipin	2F14DM	(2) F14WT5/Mini Bipin DM	2F24	(2) F24WT5H0/Mini Bipin	2F24DM	(2) F24WT5H0/Mini Bipin DM	2F17	(2) F17WT8/Med Bipin	120 277	<table border="1"> <tr><td>PT_</td><td>Painted (Include Paint Number)</td></tr> <tr><td>BAL</td><td>Brushed Aluminum</td></tr> </table> <p>See Advent Finish Selection Guide, on page 17.</p>	PT_	Painted (Include Paint Number)	BAL	Brushed Aluminum	<table border="1"> <tr><td>CG01</td><td>Red Color Gel</td></tr> <tr><td>CG02</td><td>Orange Color Gel</td></tr> <tr><td>CG03</td><td>Green Color Gel</td></tr> <tr><td>CG04</td><td>Blue Color Gel</td></tr> </table> <p>If no color is specified, fixture ships with standard white lens. For further details on specifying lenses, see page 16.</p>	CG01	Red Color Gel	CG02	Orange Color Gel	CG03	Green Color Gel	CG04	Blue Color Gel	<table border="1"> <tr><td>ES1</td><td>Embossed Stainless Steel-Linear Pattern</td></tr> <tr><td>ES2</td><td>Embossed Stainless Steel-Crosshatch Pattern</td></tr> <tr><td>WF1</td><td>Cherry Laminate</td></tr> <tr><td>WF2</td><td>Maple Laminate</td></tr> </table> <p>For further details on specifying accents, see page 16.</p>	ES1	Embossed Stainless Steel-Linear Pattern	ES2	Embossed Stainless Steel-Crosshatch Pattern	WF1	Cherry Laminate	WF2	Maple Laminate
2F14	(2) F14WT5/Mini Bipin																																		
2F14DM	(2) F14WT5/Mini Bipin DM																																		
2F24	(2) F24WT5H0/Mini Bipin																																		
2F24DM	(2) F24WT5H0/Mini Bipin DM																																		
2F17	(2) F17WT8/Med Bipin																																		
PT_	Painted (Include Paint Number)																																		
BAL	Brushed Aluminum																																		
CG01	Red Color Gel																																		
CG02	Orange Color Gel																																		
CG03	Green Color Gel																																		
CG04	Blue Color Gel																																		
ES1	Embossed Stainless Steel-Linear Pattern																																		
ES2	Embossed Stainless Steel-Crosshatch Pattern																																		
WF1	Cherry Laminate																																		
WF2	Maple Laminate																																		
39" AIW1526	<table border="1"> <tr><td>2F21</td><td>(2) F21WT5/Mini Bipin</td></tr> <tr><td>2F21DM</td><td>(2) F21WT5/Mini Bipin DM</td></tr> <tr><td>2F39</td><td>(2) F39WT5H0/Mini Bipin</td></tr> <tr><td>2F39DM</td><td>(2) F39WT5H0/Mini Bipin DM</td></tr> <tr><td>2F25</td><td>(2) F25WT8/Med Bipin</td></tr> </table>	2F21	(2) F21WT5/Mini Bipin	2F21DM	(2) F21WT5/Mini Bipin DM	2F39	(2) F39WT5H0/Mini Bipin	2F39DM	(2) F39WT5H0/Mini Bipin DM	2F25	(2) F25WT8/Med Bipin																								
2F21	(2) F21WT5/Mini Bipin																																		
2F21DM	(2) F21WT5/Mini Bipin DM																																		
2F39	(2) F39WT5H0/Mini Bipin																																		
2F39DM	(2) F39WT5H0/Mini Bipin DM																																		
2F25	(2) F25WT8/Med Bipin																																		
52" AIW1532	<table border="1"> <tr><td>2F28</td><td>(2) F28WT5/Mini Bipin</td></tr> <tr><td>2F28DM</td><td>(2) F28WT5/Mini Bipin DM</td></tr> <tr><td>2F54</td><td>(2) F54WT5H0/Mini Bipin</td></tr> <tr><td>2F54DM</td><td>(2) F54WT5H0/Mini Bipin DM</td></tr> <tr><td>2F32</td><td>(2) F32WT8/Med Bipin</td></tr> </table>	2F28	(2) F28WT5/Mini Bipin	2F28DM	(2) F28WT5/Mini Bipin DM	2F54	(2) F54WT5H0/Mini Bipin	2F54DM	(2) F54WT5H0/Mini Bipin DM	2F32	(2) F32WT8/Med Bipin																								
2F28	(2) F28WT5/Mini Bipin																																		
2F28DM	(2) F28WT5/Mini Bipin DM																																		
2F54	(2) F54WT5H0/Mini Bipin																																		
2F54DM	(2) F54WT5H0/Mini Bipin DM																																		
2F32	(2) F32WT8/Med Bipin																																		

MODEL DIMENSIONS				
	W	H	D	MC
AIW1520	13.0"	28.0"	3.75"	14.0"
AIW1526	13.0"	39.0"	3.75"	19.5"
AIW1532	13.0"	52.0"	3.75"	26.0"

LENSES	
CG01	CG02
CG03	CG04

OPTIONAL ACCENTS	
ES1	ES2
WF1	WF2

NOTE: The swatches shown are printed representations of our standard lenses and optional accents. Actual product finishes and materials may vary slightly from the samples shown here. Consult factory for custom configurations.

Reo Interior Sconce

Surface Mount - 3D Open Window

ADVENT



ADA

AIW1544

(BAL FINISH - TP02 PANEL - WF2 ACCENT)



ADA

AIW1544

(BAL FINISH - TP03 PANEL)



ADA

Translucent Panels

Reo is offered with the popular 3form® Varia resin panels and Advent's hand-painted lenses to provide depth and visual interest.

The use of 3form® Varia materials allows the addition of a natural element to a space. Other panels are available. Please consult factory for more details.



TP01 Bear Grass

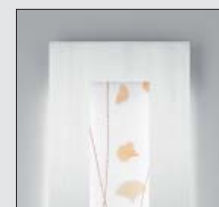

TP02 Gingko Thatch



TP03 Quo Mezzo

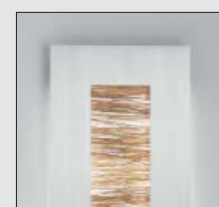

TP04 Bear Grass

Sample model number: **AIW1538 - 2F14 - 120 - BAL - HP01 - ES1**

SELECT MODEL NO.	SELECT LAMPING	SELECT VOLTAGE	SELECT FINISH	SELECT LENS/PANEL	SELECT OPTIONAL ACCENT																																						
28" AIW1538	<p>Lamping Detail</p> <table border="1"> <tr><td>2F14</td><td>(2) F14WT5/Mini Bipin</td></tr> <tr><td>2F14DM</td><td>(2) F14WT5/Mini Bipin DM</td></tr> <tr><td>2F24</td><td>(2) F24WT5H0/Mini Bipin</td></tr> <tr><td>2F24DM</td><td>(2) F24WT5H0/Mini Bipin DM</td></tr> <tr><td>2F17</td><td>(2) F17WT8/Med Bipin</td></tr> </table>	2F14	(2) F14WT5/Mini Bipin	2F14DM	(2) F14WT5/Mini Bipin DM	2F24	(2) F24WT5H0/Mini Bipin	2F24DM	(2) F24WT5H0/Mini Bipin DM	2F17	(2) F17WT8/Med Bipin	120 277	<table border="1"> <tr><td>PT_</td><td>Painted (Include Paint Number)</td></tr> <tr><td>BAL</td><td>Brushed Aluminum</td></tr> </table> <p>See Advent Finish Selection Guide, on page 17.</p>	PT_	Painted (Include Paint Number)	BAL	Brushed Aluminum	<table border="1"> <tr><td>HP01</td><td>Hand-Painted Lens, Silver</td></tr> <tr><td>HP02</td><td>Hand-Painted Lens, Beige</td></tr> <tr><td>HP03</td><td>Hand-Painted Lens, Amber</td></tr> <tr><td>TP01</td><td>Translucent Panel, Vertical Bear Grass</td></tr> <tr><td>TP02</td><td>Translucent Panel, Vertical Gingko Thatch</td></tr> <tr><td>TP03</td><td>Translucent Panel, Quo Mezzo</td></tr> <tr><td>TP04</td><td>Translucent Panel, Horizontal Bear Grass</td></tr> <tr><td>TP05</td><td>Translucent Panel, Horizontal Gingko Thatch</td></tr> </table> <p>For further explanation on specifying panels, see page 14. For further details on specifying, see page 16.</p>	HP01	Hand-Painted Lens, Silver	HP02	Hand-Painted Lens, Beige	HP03	Hand-Painted Lens, Amber	TP01	Translucent Panel, Vertical Bear Grass	TP02	Translucent Panel, Vertical Gingko Thatch	TP03	Translucent Panel, Quo Mezzo	TP04	Translucent Panel, Horizontal Bear Grass	TP05	Translucent Panel, Horizontal Gingko Thatch	<table border="1"> <tr><td>ES1</td><td>Embossed Stainless Steel-Linear Pattern</td></tr> <tr><td>ES2</td><td>Embossed Stainless Steel-Crosshatch Pattern</td></tr> <tr><td>WF1</td><td>Cherry Laminate</td></tr> <tr><td>WF2</td><td>Maple Laminate</td></tr> </table> <p>For further details on specifying accents, see page 16.</p>	ES1	Embossed Stainless Steel-Linear Pattern	ES2	Embossed Stainless Steel-Crosshatch Pattern	WF1	Cherry Laminate	WF2	Maple Laminate
2F14	(2) F14WT5/Mini Bipin																																										
2F14DM	(2) F14WT5/Mini Bipin DM																																										
2F24	(2) F24WT5H0/Mini Bipin																																										
2F24DM	(2) F24WT5H0/Mini Bipin DM																																										
2F17	(2) F17WT8/Med Bipin																																										
PT_	Painted (Include Paint Number)																																										
BAL	Brushed Aluminum																																										
HP01	Hand-Painted Lens, Silver																																										
HP02	Hand-Painted Lens, Beige																																										
HP03	Hand-Painted Lens, Amber																																										
TP01	Translucent Panel, Vertical Bear Grass																																										
TP02	Translucent Panel, Vertical Gingko Thatch																																										
TP03	Translucent Panel, Quo Mezzo																																										
TP04	Translucent Panel, Horizontal Bear Grass																																										
TP05	Translucent Panel, Horizontal Gingko Thatch																																										
ES1	Embossed Stainless Steel-Linear Pattern																																										
ES2	Embossed Stainless Steel-Crosshatch Pattern																																										
WF1	Cherry Laminate																																										
WF2	Maple Laminate																																										
39" AIW1544	<table border="1"> <tr><td>2F21</td><td>(2) F21WT5/Mini Bipin</td></tr> <tr><td>2F21DM</td><td>(2) F21WT5/Mini Bipin DM</td></tr> <tr><td>2F39</td><td>(2) F39WT5H0/Mini Bipin</td></tr> <tr><td>2F39DM</td><td>(2) F39WT5H0/Mini Bipin DM</td></tr> <tr><td>2F25</td><td>(2) F25WT8/Med Bipin</td></tr> </table>	2F21	(2) F21WT5/Mini Bipin	2F21DM	(2) F21WT5/Mini Bipin DM	2F39	(2) F39WT5H0/Mini Bipin	2F39DM	(2) F39WT5H0/Mini Bipin DM	2F25	(2) F25WT8/Med Bipin																																
2F21	(2) F21WT5/Mini Bipin																																										
2F21DM	(2) F21WT5/Mini Bipin DM																																										
2F39	(2) F39WT5H0/Mini Bipin																																										
2F39DM	(2) F39WT5H0/Mini Bipin DM																																										
2F25	(2) F25WT8/Med Bipin																																										
52" AIW1550	<table border="1"> <tr><td>2F28</td><td>(2) F28WT5/Mini Bipin</td></tr> <tr><td>2F28DM</td><td>(2) F28WT5/Mini Bipin DM</td></tr> <tr><td>2F54</td><td>(2) F54WT5H0/Mini Bipin</td></tr> <tr><td>2F54DM</td><td>(2) F54WT5H0/Mini Bipin DM</td></tr> <tr><td>2F32</td><td>(2) F32WT8/Med Bipin</td></tr> </table>	2F28	(2) F28WT5/Mini Bipin	2F28DM	(2) F28WT5/Mini Bipin DM	2F54	(2) F54WT5H0/Mini Bipin	2F54DM	(2) F54WT5H0/Mini Bipin DM	2F32	(2) F32WT8/Med Bipin																																
2F28	(2) F28WT5/Mini Bipin																																										
2F28DM	(2) F28WT5/Mini Bipin DM																																										
2F54	(2) F54WT5H0/Mini Bipin																																										
2F54DM	(2) F54WT5H0/Mini Bipin DM																																										
2F32	(2) F32WT8/Med Bipin																																										

MODEL DIMENSIONS				
	W	H	D	MC
AIW1538	13.0"	28.0"	3.75"	14.0"
AIW1544	13.0"	39.0"	3.75"	19.5"
AIW1550	13.0"	52.0"	3.75"	26.0"

LENSES AND PANELS		
HP01	HP02	HP03
TP01	TP02	TP03
TP04	TP05	

OPTIONAL ACCENTS	
ES1	ES2
WF1	WF2

NOTE: The swatches shown are printed representations of our standard lenses, panels and optional accents. Actual product finishes and materials may vary slightly from the samples shown here. Consult factory for custom configurations.

Reo Interior Sconce

Semi-Recessed Mount - Flush Front Lens

ADVENT



AIW1528
(BAL FINISH - CG02 LENS)



AIW1528
(PT11 FINISH - ES1 ACCENT)



Lens Construction

The Reo flush front lens creates a stylish appearance through strategically layered components.

The opal acrylic panel provides a protective layer and creates a uniform appearance through light

diffusion, the color gel adds versatility through color customization and the UV filter provides the color gel additional protection from the lamp.

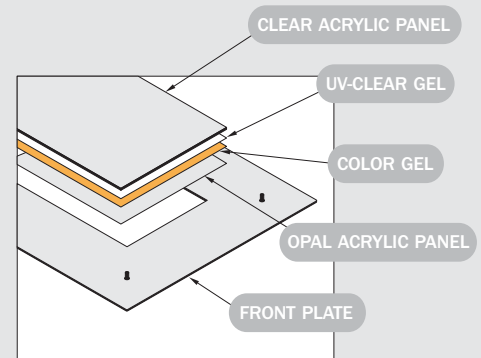

Sample model number: **AIW1522 - 2F14 - 120 - BAL - CG01 - ES1**

SELECT MODEL NO.	SELECT LAMPING	SELECT VOLTAGE	SELECT FINISH	SELECT LENS	SELECT OPTIONAL ACCENT
28" AIW1522	Lamping Detail 2F14 (2) F14WT5/Mini Bipin 2F14DM (2) F14WT5/Mini Bipin DM 2F24 (2) F24WT5H0/Mini Bipin 2F24DM (2) F24WT5H0/Mini Bipin DM 2F17 (2) F17WT8/Med Bipin	120 277	PT_ Painted (Include Paint Number) BAL Brushed Aluminum See Advent Finish Selection Guide, on page 17.	CG01 Red Color Gel CG02 Orange Color Gel CG03 Green Color Gel CG04 Blue Color Gel If no color is specified, fixture ships with standard white lens. For further details on specifying lenses, see page 16.	ES1 Embossed Stainless Steel-Linear Pattern ES2 Embossed Stainless Steel-Crosshatch Pattern WF1 Cherry Laminate WF2 Maple Laminate For further details on specifying accents, see page 16.
39" AIW1528	2F21 (2) F21WT5/Mini Bipin 2F21DM (2) F21WT5/Mini Bipin DM 2F39 (2) F39WT5H0/Mini Bipin 2F39DM (2) F39WT5H0/Mini Bipin DM 2F25 (2) F25WT8/Med Bipin				
52" AIW1534	2F28 (2) F28WT5/Mini Bipin 2F28DM (2) F28WT5/Mini Bipin DM 2F54 (2) F54WT5H0/Mini Bipin 2F54DM (2) F54WT5H0/Mini Bipin DM 2F32 (2) F32WT8/Med Bipin				

MODEL DIMENSIONS				
	W	H	D	MC
AIW1522	13.0"	28.0"	1.75"	14.0"
AIW1528	13.0"	39.0"	1.75"	19.5"
AIW1534	13.0"	52.0"	1.75"	26.0"

LENSES	
CG01	CG02
CG03	CG04

OPTIONAL ACCENTS	
ES1	ES2
WF1	WF2

NOTE: The swatches shown are printed representations of our standard lenses and optional accents. Actual product finishes and materials may vary slightly from the samples shown here. Consult factory for custom configurations.

Reo Interior Sconce

Semi-Recessed Mount - 3D Open Window

ADVENT



AIW1546

(PT11 FINISH - HP01 LENS - WF1 ACCENT)



AIW1546

(BAL FINISH - TP02 PANEL)

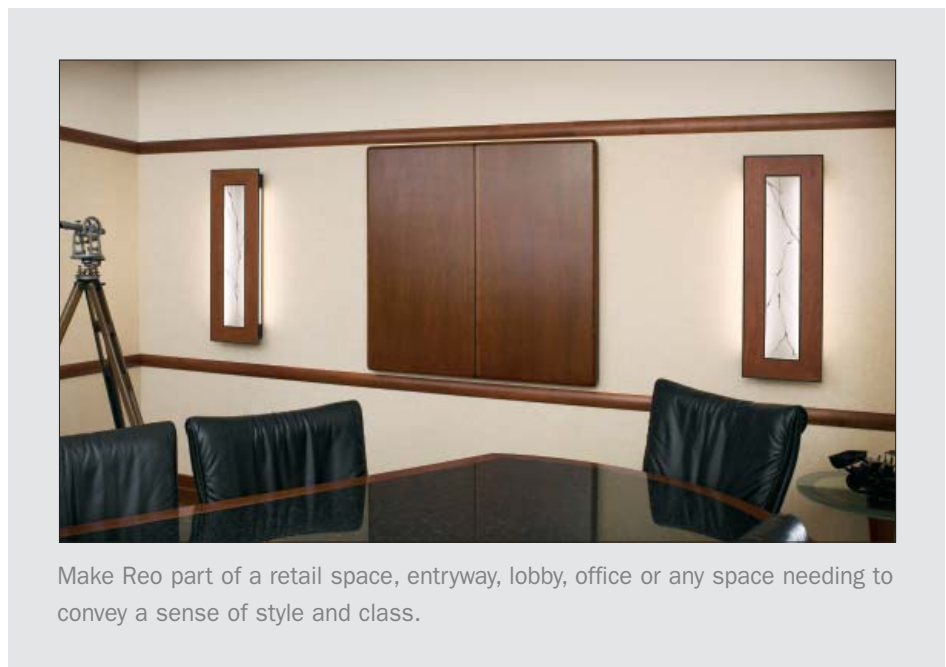

Make Reo part of a retail space, entryway, lobby, office or any space needing to convey a sense of style and class.

Sample model number: **AIW1540 - 2F14 - 120 - BAL - HP01 - ES1**

SELECT MODEL NO.	SELECT LAMPING	SELECT VOLTAGE	SELECT FINISH	SELECT LENS/PANEL	SELECT OPTIONAL ACCENT																																						
28" AIW1540	<p>Lamping Detail</p> <table border="1"> <tr><td>2F14</td><td>(2) F14WT5/Mini Bipin</td></tr> <tr><td>2F14DM</td><td>(2) F14WT5/Mini Bipin DM</td></tr> <tr><td>2F24</td><td>(2) F24WT5H0/Mini Bipin</td></tr> <tr><td>2F24DM</td><td>(2) F24WT5H0/Mini Bipin DM</td></tr> <tr><td>2F17</td><td>(2) F17WT8/Med Bipin</td></tr> </table>	2F14	(2) F14WT5/Mini Bipin	2F14DM	(2) F14WT5/Mini Bipin DM	2F24	(2) F24WT5H0/Mini Bipin	2F24DM	(2) F24WT5H0/Mini Bipin DM	2F17	(2) F17WT8/Med Bipin	120 277	<table border="1"> <tr><td>PT_</td><td>Painted (Include Paint Number)</td></tr> <tr><td>BAL</td><td>Brushed Aluminum</td></tr> </table> <p>See Advent Finish Selection Guide, on page 17.</p>	PT_	Painted (Include Paint Number)	BAL	Brushed Aluminum	<table border="1"> <tr><td>HP01</td><td>Hand-Painted Lens, Silver</td></tr> <tr><td>HP02</td><td>Hand-Painted Lens, Beige</td></tr> <tr><td>HP03</td><td>Hand-Painted Lens, Amber</td></tr> <tr><td>TP01</td><td>Translucent Panel, Vertical Bear Grass</td></tr> <tr><td>TP02</td><td>Translucent Panel, Vertical Gingko Thatch</td></tr> <tr><td>TP03</td><td>Translucent Panel, Quo Mezzo</td></tr> <tr><td>TP04</td><td>Translucent Panel, Horizontal Bear Grass</td></tr> <tr><td>TP05</td><td>Translucent Panel, Horizontal Gingko Thatch</td></tr> </table> <p>For further explanation on specifying panels, see page 14. For further details on specifying, see page 16.</p>	HP01	Hand-Painted Lens, Silver	HP02	Hand-Painted Lens, Beige	HP03	Hand-Painted Lens, Amber	TP01	Translucent Panel, Vertical Bear Grass	TP02	Translucent Panel, Vertical Gingko Thatch	TP03	Translucent Panel, Quo Mezzo	TP04	Translucent Panel, Horizontal Bear Grass	TP05	Translucent Panel, Horizontal Gingko Thatch	<table border="1"> <tr><td>ES1</td><td>Embossed Stainless Steel-Linear Pattern</td></tr> <tr><td>ES2</td><td>Embossed Stainless Steel-Crosshatch Pattern</td></tr> <tr><td>WF1</td><td>Cherry Laminate</td></tr> <tr><td>WF2</td><td>Maple Laminate</td></tr> </table> <p>For further details on specifying accents, see page 16.</p>	ES1	Embossed Stainless Steel-Linear Pattern	ES2	Embossed Stainless Steel-Crosshatch Pattern	WF1	Cherry Laminate	WF2	Maple Laminate
2F14	(2) F14WT5/Mini Bipin																																										
2F14DM	(2) F14WT5/Mini Bipin DM																																										
2F24	(2) F24WT5H0/Mini Bipin																																										
2F24DM	(2) F24WT5H0/Mini Bipin DM																																										
2F17	(2) F17WT8/Med Bipin																																										
PT_	Painted (Include Paint Number)																																										
BAL	Brushed Aluminum																																										
HP01	Hand-Painted Lens, Silver																																										
HP02	Hand-Painted Lens, Beige																																										
HP03	Hand-Painted Lens, Amber																																										
TP01	Translucent Panel, Vertical Bear Grass																																										
TP02	Translucent Panel, Vertical Gingko Thatch																																										
TP03	Translucent Panel, Quo Mezzo																																										
TP04	Translucent Panel, Horizontal Bear Grass																																										
TP05	Translucent Panel, Horizontal Gingko Thatch																																										
ES1	Embossed Stainless Steel-Linear Pattern																																										
ES2	Embossed Stainless Steel-Crosshatch Pattern																																										
WF1	Cherry Laminate																																										
WF2	Maple Laminate																																										
39" AIW1546	<table border="1"> <tr><td>2F21</td><td>(2) F21WT5/Mini Bipin</td></tr> <tr><td>2F21DM</td><td>(2) F21WT5/Mini Bipin DM</td></tr> <tr><td>2F39</td><td>(2) F39WT5H0/Mini Bipin</td></tr> <tr><td>2F39DM</td><td>(2) F39WT5H0/Mini Bipin DM</td></tr> <tr><td>2F25</td><td>(2) F25WT8/Med Bipin</td></tr> </table>	2F21	(2) F21WT5/Mini Bipin	2F21DM	(2) F21WT5/Mini Bipin DM	2F39	(2) F39WT5H0/Mini Bipin	2F39DM	(2) F39WT5H0/Mini Bipin DM	2F25	(2) F25WT8/Med Bipin																																
2F21	(2) F21WT5/Mini Bipin																																										
2F21DM	(2) F21WT5/Mini Bipin DM																																										
2F39	(2) F39WT5H0/Mini Bipin																																										
2F39DM	(2) F39WT5H0/Mini Bipin DM																																										
2F25	(2) F25WT8/Med Bipin																																										
52" AIW1552	<table border="1"> <tr><td>2F28</td><td>(2) F28WT5/Mini Bipin</td></tr> <tr><td>2F28DM</td><td>(2) F28WT5/Mini Bipin DM</td></tr> <tr><td>2F54</td><td>(2) F54WT5H0/Mini Bipin</td></tr> <tr><td>2F54DM</td><td>(2) F54WT5H0/Mini Bipin DM</td></tr> <tr><td>2F32</td><td>(2) F32WT8/Med Bipin</td></tr> </table>	2F28	(2) F28WT5/Mini Bipin	2F28DM	(2) F28WT5/Mini Bipin DM	2F54	(2) F54WT5H0/Mini Bipin	2F54DM	(2) F54WT5H0/Mini Bipin DM	2F32	(2) F32WT8/Med Bipin																																
2F28	(2) F28WT5/Mini Bipin																																										
2F28DM	(2) F28WT5/Mini Bipin DM																																										
2F54	(2) F54WT5H0/Mini Bipin																																										
2F54DM	(2) F54WT5H0/Mini Bipin DM																																										
2F32	(2) F32WT8/Med Bipin																																										

MODEL DIMENSIONS				
	W	H	D	MC
AIW1540	13.0"	28.0"	1.75"	14.0"
AIW1546	13.0"	39.0"	1.75"	19.5"
AIW1552	13.0"	52.0"	1.75"	26.0"

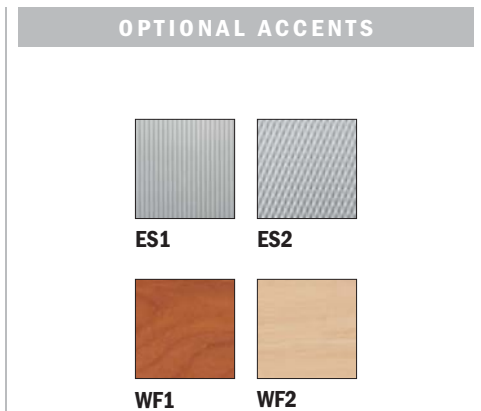
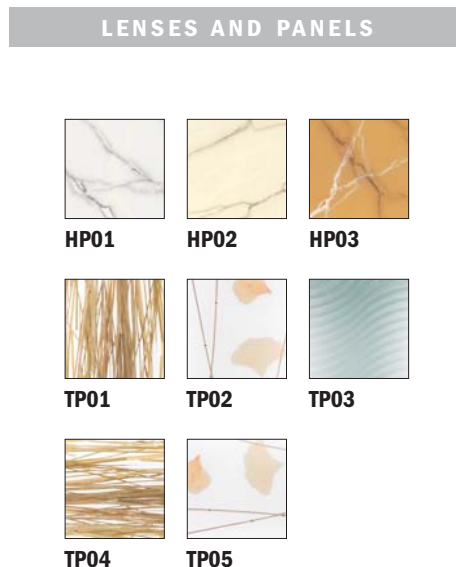

NOTE: The swatches shown are printed representations of our standard lenses, panels and optional accents. Actual product finishes and materials may vary slightly from the samples shown here. Consult factory for custom configurations.

Reo Interior Sconce

Recessed Mount - Flush Front Lens

ADVENT



AIW1530
(BAL FINISH - WF2 ACCENT)

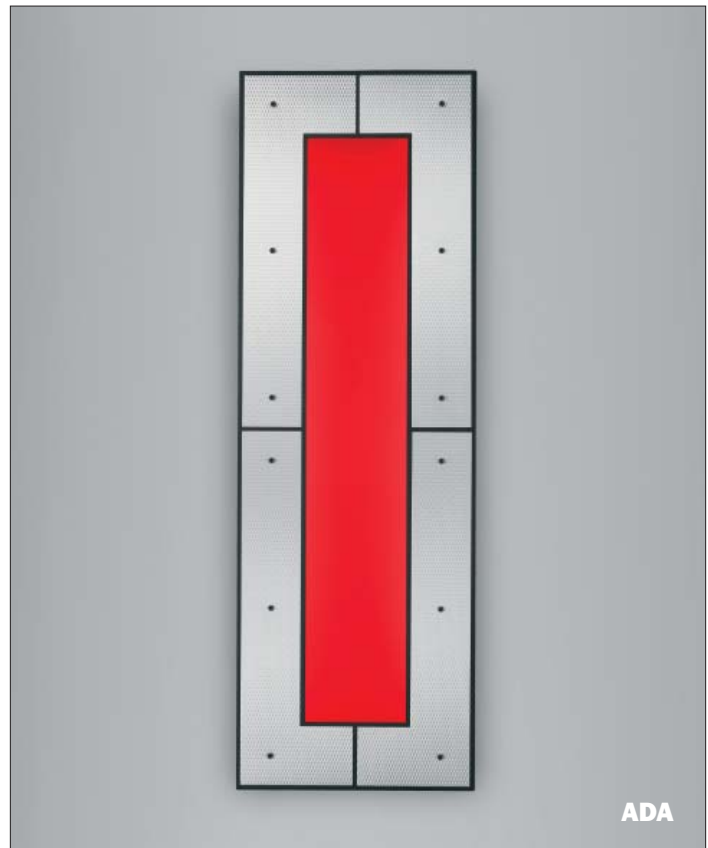

AIW1530
(PT11 FINISH - CG01 LENS - ES2 ACCENT)

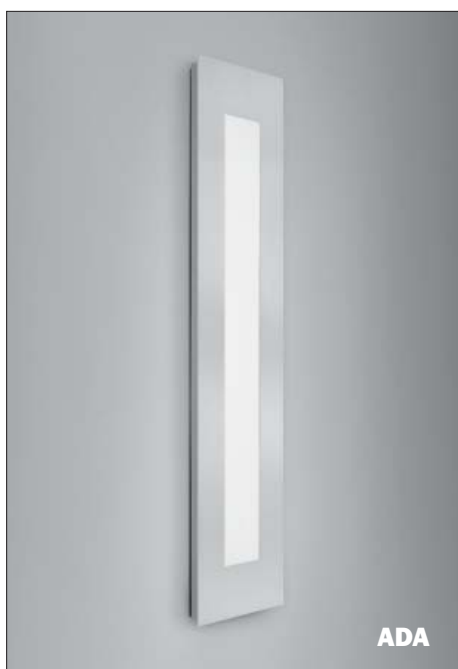

Mounting Options

Style and versatility meet safety, as Reo is available in three ADA compliant mounts, all of which can be installed vertically or horizontally.

Surface - mounts directly to the wall with side illumination.

Semi-Recessed - slightly recessed to provide a lower profile with moderate side illumination.

Recessed - fully recessed housing to provide the lowest profile and no side illumination.



Surface Mount



Semi-Recessed Mount



Recessed Mount

Sample model number: **AIW1524 - 2F14 - 120 - BAL - CG03 - ES2**

SELECT MODEL NO.	SELECT LAMPING	SELECT VOLTAGE	SELECT FINISH	SELECT LENS	SELECT OPTIONAL ACCENT
28" AIW1524	Lamping Detail 2F14 (2) F14WT5/Mini Bipin 2F14DM (2) F14WT5/Mini Bipin DM 2F24 (2) F24WT5H0/Mini Bipin 2F24DM (2) F24WT5H0/Mini Bipin DM 2F17 (2) F17WT8/Med Bipin	120 277	PT_ Painted (Include Paint Number) BAL Brushed Aluminum See Advent Finish Selection Guide, on page 17.	CG01 Red Color Gel CG02 Orange Color Gel CG03 Green Color Gel CG04 Blue Color Gel If no color is specified, fixture ships with standard white lens. For further details on specifying lenses, see page 16.	ES1 Embossed Stainless Steel-Linear Pattern ES2 Embossed Stainless Steel-Crosshatch Pattern WF1 Cherry Laminate WF2 Maple Laminate For further details on specifying accents, see page 16.
39" AIW1530	2F21 (2) F21WT5/Mini Bipin 2F21DM (2) F21WT5/Mini Bipin DM 2F39 (2) F39WT5H0/Mini Bipin 2F39DM (2) F39WT5H0/Mini Bipin DM 2F25 (2) F25WT8/Med Bipin				
52" AIW1536	2F28 (2) F28WT5/Mini Bipin 2F28DM (2) F28WT5/Mini Bipin DM 2F54 (2) F54WT5H0/Mini Bipin 2F54DM (2) F54WT5H0/Mini Bipin DM 2F32 (2) F32WT8/Med Bipin				

MODEL DIMENSIONS				
	W	H	D	MC
AIW1524	13.0"	28.0"	1.00"	14.0"
AIW1530	13.0"	39.0"	1.00"	19.5"
AIW1536	13.0"	52.0"	1.00"	26.0"

LENSES	
CG01	CG02
CG03	CG04

OPTIONAL ACCENTS	
ES1	ES2
WF1	WF2

NOTE: The swatches shown are printed representations of our standard lenses and optional accents. Actual product finishes and materials may vary slightly from the samples shown here. Consult factory for custom configurations.

Reo Interior Sconce

Recessed Mount - 3D Open Window

ADVENT



AIW1548

(PT11 FINISH - HPO1 LENS - ES1 ACCENT)



AIW1548

(BAL FINISH - HPO2 PANEL - WF2 ACCENT)



ADA

Mounting and Panel Orientation

Reo fixtures can be mounted horizontally or vertically and directional panels are offered in two versions to maximize design capabilities. Mounting affects which panel to specify. See the example below or consult factory for assistance.



TP01



TP04



TP04



TP01

Sample model number: **AIW1542 - 2F14 - 120 - BAL - HP01 - ES1**

SELECT MODEL NO.	SELECT LAMPING	SELECT VOLTAGE	SELECT FINISH	SELECT LENS/PANEL	SELECT OPTIONAL ACCENT																																								
28" AIW1542	<p>Lamping Detail</p> <table border="1"> <tr><td>2F14</td><td>(2) F14WT5/Mini Bipin</td></tr> <tr><td>2F14DM</td><td>(2) F14WT5/Mini Bipin DM</td></tr> <tr><td>2F24</td><td>(2) F24WT5H0/Mini Bipin</td></tr> <tr><td>2F24DM</td><td>(2) F24WT5H0/Mini Bipin DM</td></tr> <tr><td>2F17</td><td>(2) F17WT8/Med Bipin</td></tr> </table>	2F14	(2) F14WT5/Mini Bipin	2F14DM	(2) F14WT5/Mini Bipin DM	2F24	(2) F24WT5H0/Mini Bipin	2F24DM	(2) F24WT5H0/Mini Bipin DM	2F17	(2) F17WT8/Med Bipin	<table border="1"> <tr><td>120</td></tr> <tr><td>277</td></tr> </table>	120	277	<table border="1"> <tr><td>PT_</td><td>Painted (Include Paint Number)</td></tr> <tr><td>BAL</td><td>Brushed Aluminum</td></tr> </table> <p>See Advent Finish Selection Guide, on page 17.</p>	PT_	Painted (Include Paint Number)	BAL	Brushed Aluminum	<table border="1"> <tr><td>HP01</td><td>Hand-Painted Lens, Silver</td></tr> <tr><td>HP02</td><td>Hand-Painted Lens, Beige</td></tr> <tr><td>HP03</td><td>Hand-Painted Lens, Amber</td></tr> <tr><td>TP01</td><td>Translucent Panel, Vertical Bear Grass</td></tr> <tr><td>TP02</td><td>Translucent Panel, Vertical Gingko Thatch</td></tr> <tr><td>TP03</td><td>Translucent Panel, Quo Mezzo</td></tr> <tr><td>TP04</td><td>Translucent Panel, Horizontal Bear Grass</td></tr> <tr><td>TP05</td><td>Translucent Panel, Horizontal Gingko Thatch</td></tr> </table> <p>For further explanation on specifying panels, see page 14. For further details on specifying, see page 16.</p>	HP01	Hand-Painted Lens, Silver	HP02	Hand-Painted Lens, Beige	HP03	Hand-Painted Lens, Amber	TP01	Translucent Panel, Vertical Bear Grass	TP02	Translucent Panel, Vertical Gingko Thatch	TP03	Translucent Panel, Quo Mezzo	TP04	Translucent Panel, Horizontal Bear Grass	TP05	Translucent Panel, Horizontal Gingko Thatch	<table border="1"> <tr><td>ES1</td><td>Embossed Stainless Steel-Linear Pattern</td></tr> <tr><td>ES2</td><td>Embossed Stainless Steel-Crosshatch Pattern</td></tr> <tr><td>WF1</td><td>Cherry Laminate</td></tr> <tr><td>WF2</td><td>Maple Laminate</td></tr> </table> <p>For further details on specifying accents, see page 16.</p>	ES1	Embossed Stainless Steel-Linear Pattern	ES2	Embossed Stainless Steel-Crosshatch Pattern	WF1	Cherry Laminate	WF2	Maple Laminate
2F14	(2) F14WT5/Mini Bipin																																												
2F14DM	(2) F14WT5/Mini Bipin DM																																												
2F24	(2) F24WT5H0/Mini Bipin																																												
2F24DM	(2) F24WT5H0/Mini Bipin DM																																												
2F17	(2) F17WT8/Med Bipin																																												
120																																													
277																																													
PT_	Painted (Include Paint Number)																																												
BAL	Brushed Aluminum																																												
HP01	Hand-Painted Lens, Silver																																												
HP02	Hand-Painted Lens, Beige																																												
HP03	Hand-Painted Lens, Amber																																												
TP01	Translucent Panel, Vertical Bear Grass																																												
TP02	Translucent Panel, Vertical Gingko Thatch																																												
TP03	Translucent Panel, Quo Mezzo																																												
TP04	Translucent Panel, Horizontal Bear Grass																																												
TP05	Translucent Panel, Horizontal Gingko Thatch																																												
ES1	Embossed Stainless Steel-Linear Pattern																																												
ES2	Embossed Stainless Steel-Crosshatch Pattern																																												
WF1	Cherry Laminate																																												
WF2	Maple Laminate																																												
39" AIW1548	<table border="1"> <tr><td>2F21</td><td>(2) F21WT5/Mini Bipin</td></tr> <tr><td>2F21DM</td><td>(2) F21WT5/Mini Bipin DM</td></tr> <tr><td>2F39</td><td>(2) F39WT5H0/Mini Bipin</td></tr> <tr><td>2F39DM</td><td>(2) F39WT5H0/Mini Bipin DM</td></tr> <tr><td>2F25</td><td>(2) F25WT8/Med Bipin</td></tr> </table>	2F21	(2) F21WT5/Mini Bipin	2F21DM	(2) F21WT5/Mini Bipin DM	2F39	(2) F39WT5H0/Mini Bipin	2F39DM	(2) F39WT5H0/Mini Bipin DM	2F25	(2) F25WT8/Med Bipin																																		
2F21	(2) F21WT5/Mini Bipin																																												
2F21DM	(2) F21WT5/Mini Bipin DM																																												
2F39	(2) F39WT5H0/Mini Bipin																																												
2F39DM	(2) F39WT5H0/Mini Bipin DM																																												
2F25	(2) F25WT8/Med Bipin																																												
52" AIW1554	<table border="1"> <tr><td>2F28</td><td>(2) F28WT5/Mini Bipin</td></tr> <tr><td>2F28DM</td><td>(2) F28WT5/Mini Bipin DM</td></tr> <tr><td>2F54</td><td>(2) F54WT5H0/Mini Bipin</td></tr> <tr><td>2F54DM</td><td>(2) F54WT5H0/Mini Bipin DM</td></tr> <tr><td>2F32</td><td>(2) F32WT8/Med Bipin</td></tr> </table>	2F28	(2) F28WT5/Mini Bipin	2F28DM	(2) F28WT5/Mini Bipin DM	2F54	(2) F54WT5H0/Mini Bipin	2F54DM	(2) F54WT5H0/Mini Bipin DM	2F32	(2) F32WT8/Med Bipin																																		
2F28	(2) F28WT5/Mini Bipin																																												
2F28DM	(2) F28WT5/Mini Bipin DM																																												
2F54	(2) F54WT5H0/Mini Bipin																																												
2F54DM	(2) F54WT5H0/Mini Bipin DM																																												
2F32	(2) F32WT8/Med Bipin																																												

MODEL DIMENSIONS				
	W	H	D	MC
AIW1542	13.0"	28.0"	1.00"	14.0"
AIW1548	13.0"	39.0"	1.00"	19.5"
AIW1554	13.0"	52.0"	1.00"	26.0"

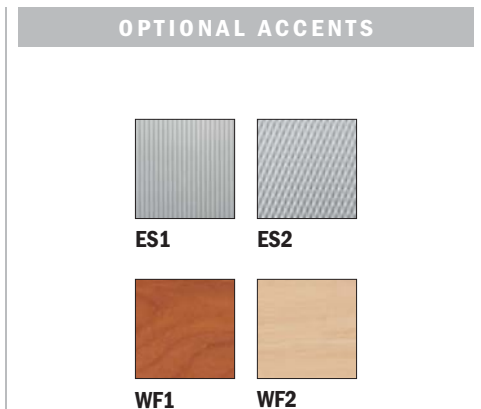
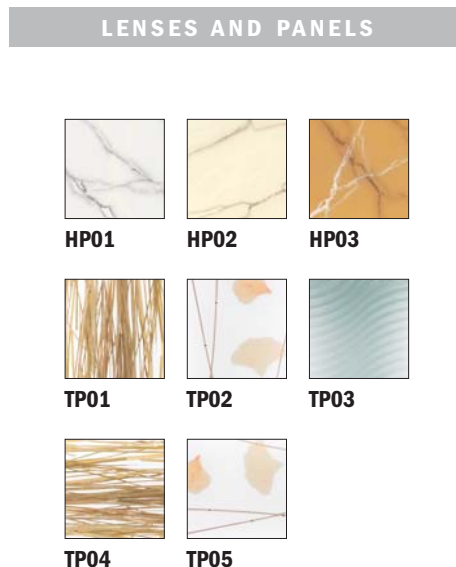

NOTE: The swatches shown are printed representations of our standard lenses, panels and optional accents. Actual product finishes and materials may vary slightly from the samples shown here. Consult factory for custom configurations.

Reo Interior Sconce

Specifying Finishes

ADVENT

How to Specify Reo's Multiple Finishes

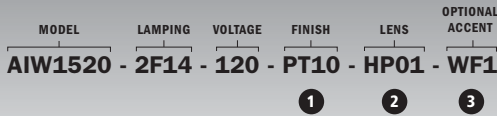

Create the ideal design solution by utilizing Reo's flexibility of finishes, colors, textures and accents. Traditional, transitional or contemporary can be achieved with Reo's nearly 22,000 possible combinations. Select the mounting style, appropriate scale and lamping, and then customize the fixture's finish in three simple steps.

- ① Housing and Faceplate Finish
- ② Lens/Panel Option
- ③ Optional Surface Accent

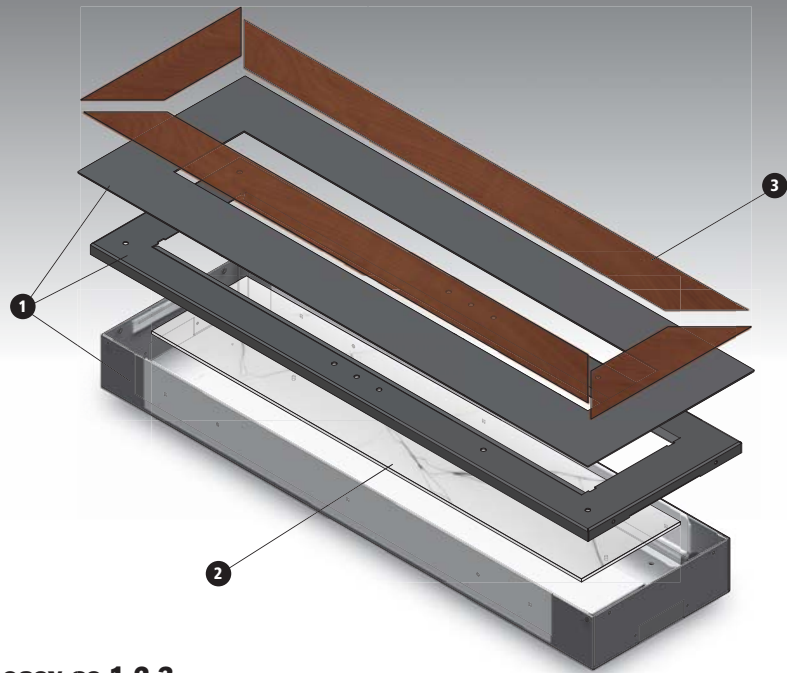

Creating your own distinct look with Reo is as easy as 1,2,3...

1 Select Finish Option

Faceplates are available in painted or brushed aluminum finishes, with all housing painted to match. Brushed aluminum faceplates receive a textured aluminum (PT46) housing. Refer to page 17 for additional finish information. Advent uses thermoset polyester powder coat paints. Over 30 standard colors are offered and others are available. Consult factory for custom configurations.



2 Select Lens/Panel Option

Flush Front Lens Options
Reo's flush front lens models allow you to add color to any space. The standard frosted white lens can be transformed with four color gels. Other colors are available upon request.

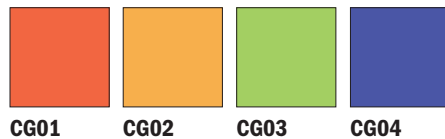

3D Open Window Lens/Panel Options

Popular 3form® Varia resin panels or Advent's unique hand-painted lenses can add texture and color.

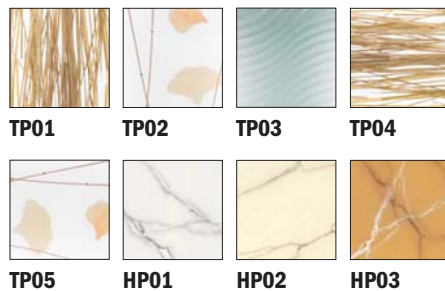

3 Select Optional Accent

Wood Laminates

Add texture and warmth with our cherry and maple wood laminate surface accents.



Textured Stainless Steel

Reo is offered with two textured stainless steel materials. Our ES1 is an embossed stainless steel-linear pattern and our ES2 is an embossed stainless steel-crosshatch pattern.

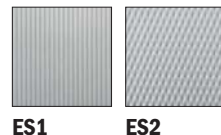

Paint Finishes

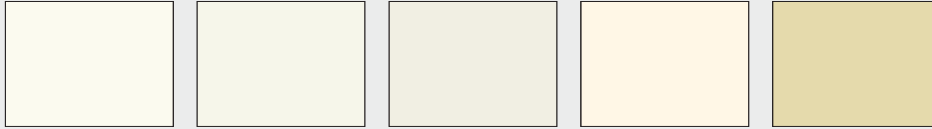

PT01 Superwhite **PT02** White **PT03** Morning Light **PT04** Warm White **PT05** Putty

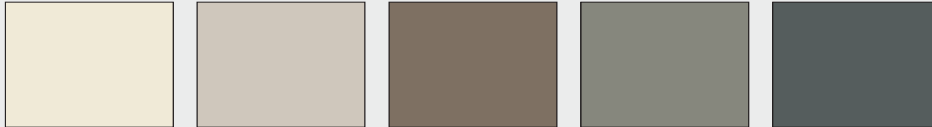

PT06 Warm Beige **PT07** Light Taupe **PT08** Medium Taupe **PT09** Medium Gray **PT10** Dark Gray



PT11 Black **PT12** Dark Chocolate **PT13** Warm Gray **PT14** Light Gray **PT15** Sage

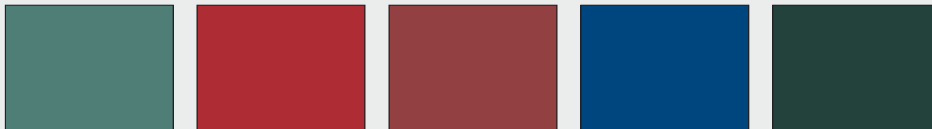

PT16 Spruce **PT17** Red **PT18** Deep Red **PT19** Blue **PT20** Dark Green

Metallic Paint Finishes

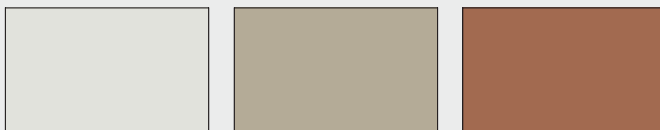

PT21 Pearl White **PT22** Platinum **PT27** Deep Copper



PT28 Dark Stainless **PT29** Red Brass **PT31** Medium Bronze

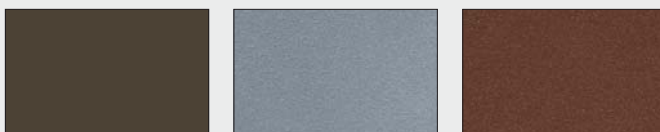

PT32 Dark Bronze **PT46** Textured Aluminum **PT47** Textured Red Brass

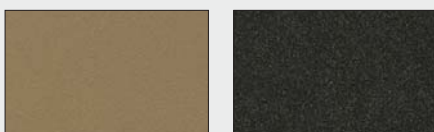

PT48 Textured Brass **PT49** Textured Bronze

Metal Finishes



BAL Brushed Solid Aluminum



ES1 Embossed Stainless
Steel-Linear Pattern



ES2 Embossed Stainless
Steel-Crosshatch Pattern

Surface Mount Flush

AIW1520	5
AIW1526	5
AIW1532	5

Surface Mount 3D Window

AIW1538	7
AIW1544	7
AIW1550	7

Semi-Recessed Mount Flush

AIW1522	9
AIW1528	9
AIW1534	9

Semi-Recessed Mount 3D Window

AIW1540	11
AIW1546	11
AIW1552	11

Recessed Mount Flush

AIW1524	13
AIW1530	13
AIW1536	13

Recessed Mount 3D Window

AIW1542	15
AIW1548	15
AIW1554	15

Customization

Advent has the ability to modify products to meet and exceed any customization demand. Reo's options include alternative translucent panels, custom faceplates, colors, materials, finishes and even painted or silk-screened logos. Think outside the box and contact Advent at 262.242.1420 or visit www.spilighting.com to make your vision, reality.

ARCHITECTURAL LIGHTING



Pendant

Advent's extensive pendant selection features luminous acrylic bowls and cylinders, as well as opal glass and spun metal options.



Chandelier

Two and four bowl configurations provide a dramatic effect for large-scale spaces. Also available in cylinder versions.



Sconce

With styles from classic to contemporary, many meeting ADA requirements, Advent sconces provide a decorative accent for any space.



Ceiling

Perfect alone, or as an complementary accent to our other families of product. Surface mount or semi-recessed versions are available.



Advent Catalog



Visit us at www.spilighting.com to learn more about SPI and our product offerings.

SPI LIGHTING

10400 NORTH ENTERPRISE DRIVE
MEQUON, WI 53092

TEL 262-242-1420
FAX 262-242-6414

WWW.SPILIGHTING.COM

1020-82